



series

RYODEN
DUMBWAITER

RYODEN LIFT
RYODEN ELEVATOR CONSTRUCTION LTD

Improved safety with more spec line-up.

The Ryoden G Series Dumbwaiter represents a more advanced environment-friendly model which offers improved operability, functionality, and safety, as well as an automatic energy-saving mode which effectively reduces power consumption.

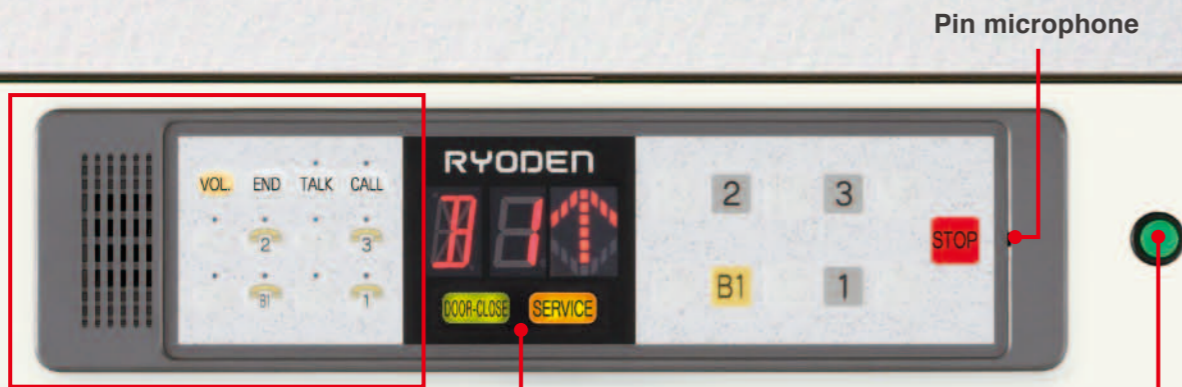

Hands-Free Interphone Convenient, requiring few button operations. during use.

Enables a volume corresponding to installed conditions with three-stage volume control.

Automatic energy-saving mode

The energy-saving mode is automatically established if the dumbwaiter is not operated within the prescribed period of time.

Large-Size Display Panel

Enables sure verification of the car status (up, down, error code), even from far away. Displays the dumbwaiter status by code (symbols and numbers).

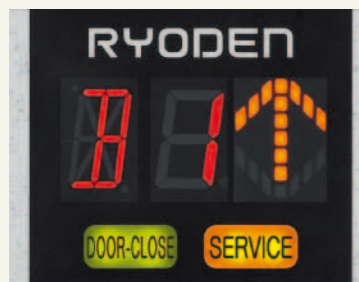

↑ Up display

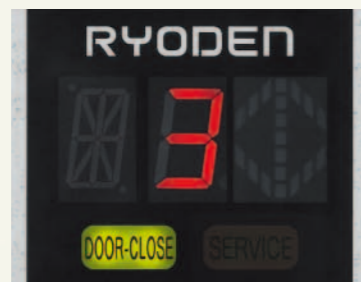

Floor number display

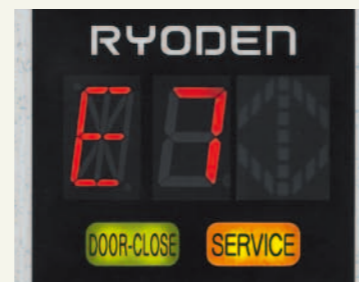

Error display

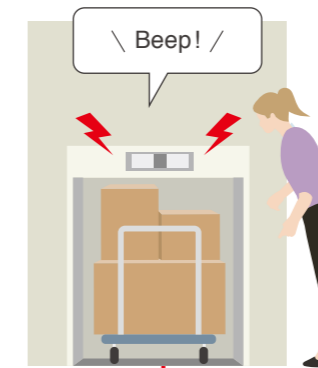

Overload alarm device

The overload alarm device prevents trouble caused by overload.

※An optional feature for RU type.

Simultaneous opening / closing of car door

The car door (inner door) automatically opens and closes when the service door is opened or closed by hand. This eliminates the double work required when taking out or putting in the goods.

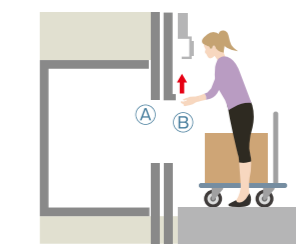

- Ⓐ The car door automatically opens when the dumbwaiter arrives on your floor.
- Ⓑ Open the service door by hand.

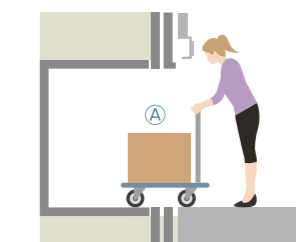

- Ⓐ Put in the goods.

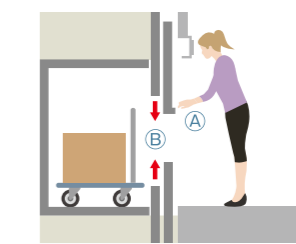

- Ⓐ Close the service door by hand.
- Ⓑ The car door automatically closes.



Specify the target floor using the operation panel. The car automatically moves to the target floor.

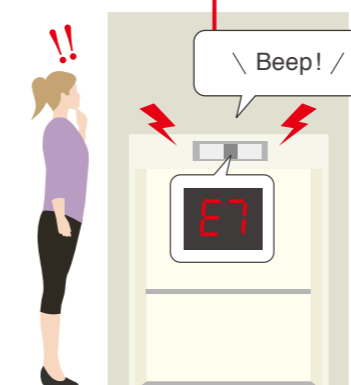

Status display

The dumbwaiter status is displayed on the operation panel with alarm call when trouble occurs.

SAFETY

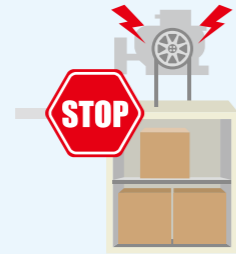

A.S.T System (Anti Stall Timer)

The A.S.T System automatically stops the motor when trouble is detected during car operation.



Door Locking Device

The service door remains locked until the car arrives, preventing from carelessly opening the service door and causing the goods to fall out.

ECOLOGY

Automatic energy-saving mode allows up to 53% of energy saving compared to the conventional Ryoden dumbwaiter.

Compared to the past series, this mode allows up to 53% of energy saving. Normal dumbwaiter operation can be resumed by pressing the Energy-saving mode release button.

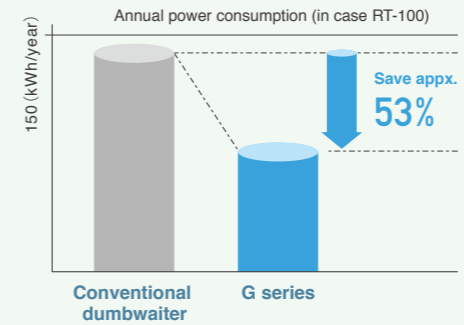

Ryoden G Series dumbwaiter is friendly specifications for environment.

Reducing environmental risk

Adoption of Pb free printed circuit board to reduce environmental risk.

Lightweight, long life

Keeping light weight but maintain strong cage structure for the long lasting dumbwaiter.

Recycling

Labeling on resin materials to prompt recycling the products.



Ryoden Elevator Construction LTD, Nagoya Works is the factory of ISO 9001/14001 certified.



Door Switch

Car operation is disabled by a switch when the door is opened. A more reliable forced locking type has also been adopted.

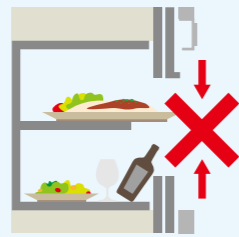

Car Door with Gate Switch

The gate switch keeps the goods from sticking out from the cage.

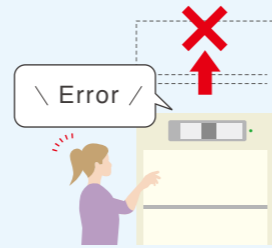

Overrun Control Switch

Two types of limit switches are provided for preventing the car from passing its destination.

Cleanliness * Optional feature

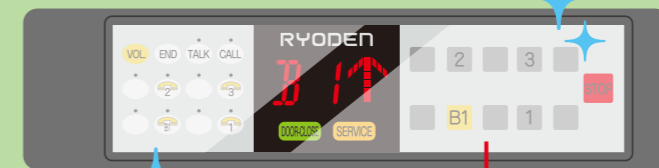

NEW

Antibacterial Specification

Antibacterial sheet is available for service door knobs and operating panels.

It's clean and easy to use!

- Characteristic**
1. Exhibiting a superior antibacterial effect on a common virus.
 2. Decreases common virus on a product.

TECHNOLOGY

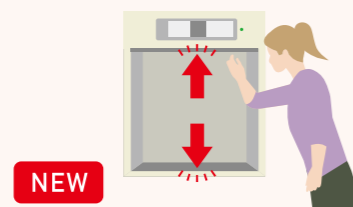

Door Holding Device

Door holding device prevents from bouncing back the service door when its closed moment

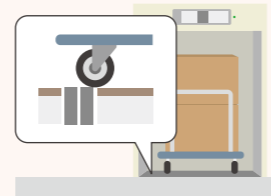

Inverter Control

The inverter accurately controls the car stop position. The stop position is maintained with high accuracy, regardless of carrying capacity.

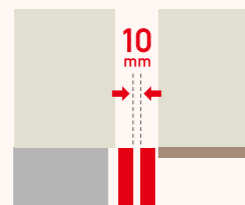

10mm gap between car and sill

The gap between the Floor Type car and sill is 10mm, allowing carts to be smoothly taken out and put in within inverter control.



Movable shelving

The Table Type allows the shelf boards to be set at five different heights in accordance with the size of the goods.

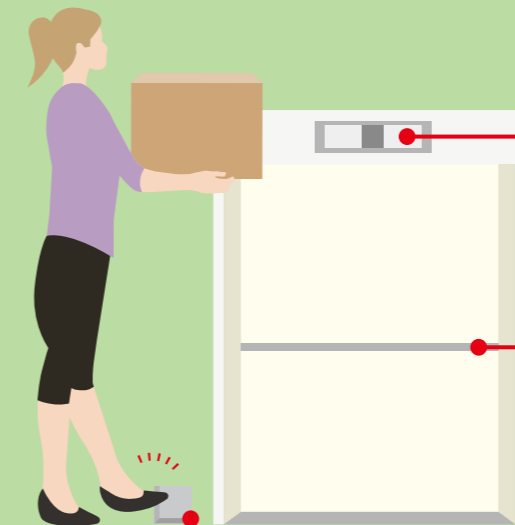

NEW

Foot Switch

Foot switch can call the car by pedaling the switch. There is no need to touch the operating panel.

Table Type / RT ▶ P9

This type is ideal for transporting small goods.

Hand carry



Floor Type / RL ▶ P13

Heavy goods can be loaded on handcarts into the car.

Carts

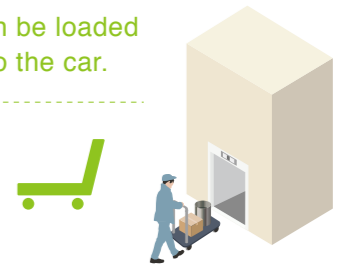

Unit Type / RU ▶ P17

This type is installable in existing buildings.

Hand carry





RT

[Table Type]

Loading Capacity:
30kg/50kg/100kg

Entrances at serving height, ensuring smooth operation.

The RT type is available to three types corresponding to the load capacity : 30kg, 50kg, and 100kg. The shelf boards inside the car can be changed to the height matched with goods.

•Major types of application / hotels, hospitals, private houses.



Standard Color variation

*Please note that the actual color may vary slightly from the above due to the printing process.

NEW



Natural White No.701



Right Gray No.602



Pink Blossom No.603

Specification

Standard Specification

Item	Material	Front surface finish
Jamb (W=300mm or less)	Steel Plate	Painted finish
Hatch door (Bi-parting)		
Table (Table depth=300mm or less)	Stainless Steel	Hairline finish
Cage (ceiling, wall)	Steel Plate	Painted finish
Cage (Shelf board 1pce)*	Stainless Steel	Hairline finish
Cage (floor)		
Cage (Bi-parting)	Steel Plate	Painted finish
Operating Panel	ABS resin	—

Stainless Steel design specification (Optional feature)

Material	Front surface finish
Stainless Steel	Hairline finish
ABS resin or stainless face plate	

*For RT-100kg, two shelves are standard.

Recommended Option



Stainless steel finish

Rust-resistant stainless steel can be applied to decorative surfaces. This also contributes to a sanitary environment.



Additional shelf

One additional shelf is available, depending on the size of goods.



Cage Lamp (LED)

Cage lighting ensures that delivered items are clearly visible in dark environments.

RT ▶ [Table Type Structure]

▼Structure(Steel frame structure)

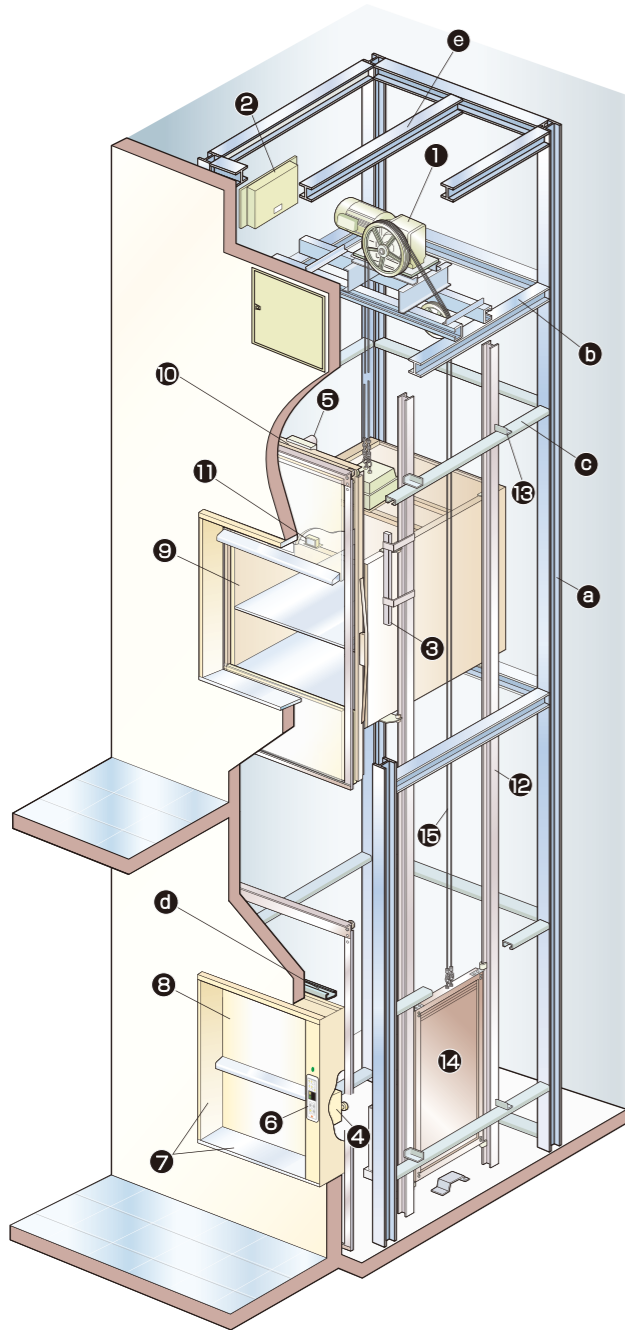

- 1 Traction Machine
- 2 Control panel, Power receiving box
- 3 Landing switch
- 4 Door locking device
- 5 Door motor
- 6 Operating panel
- 7 Jamb, Table
- 8 Hatch door (Bi-parting)
- 9 Car
- 10 Car door (Bi-parting)
- 11 Car gate switch
- 12 Guide rail
- 13 Rail bracket
- 14 CWT
- 15 Hoisting rope
- 16 Hoistway column (by owner)
- H-100×100×6×8 or bigger
- 17 Machine room support beam (by owner)
- H-100×100×6×8 or bigger
- 18 Separating beam (by owner)
- C-100×50×20×3.2 or bigger
L-50×50×6 or bigger
- 19 Jamb lintel beam (by owner)
- C-100×50×20×3.2 or bigger
L-50×50×6 or bigger
- 20 Lifting beam
- H-100×100×6×8 or bigger

* a - d show a typical example. Details may differ depending on specifications.

Steel Construction □ Dumbwaiter □ Others

▼Shaft Elevation

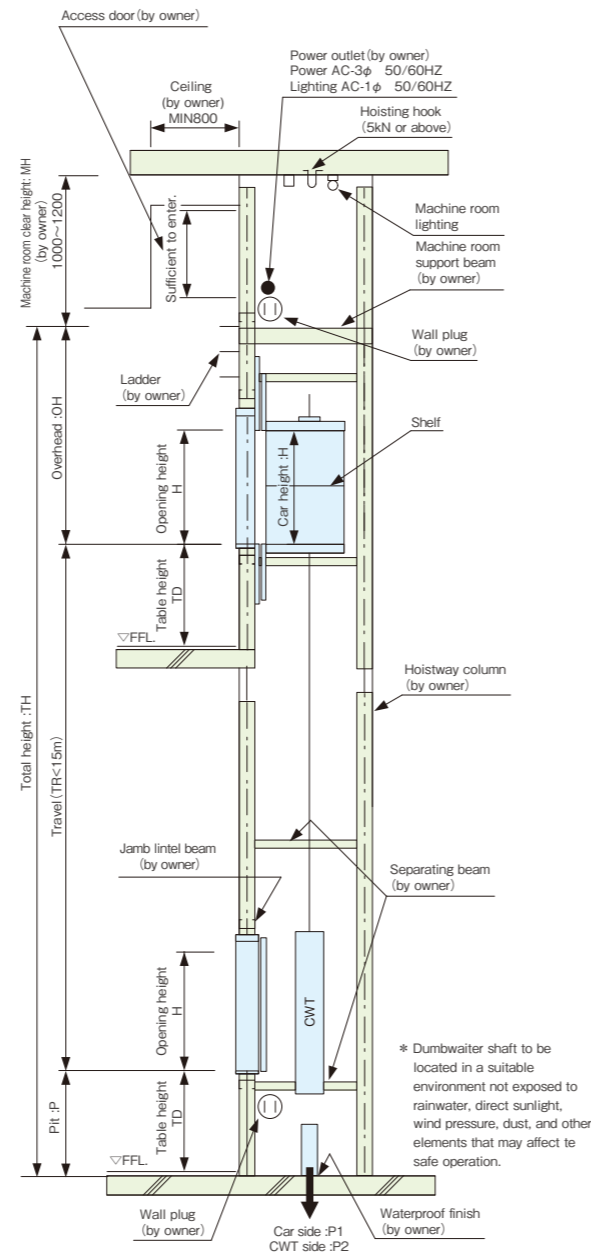

Power Feeder Data(power supply voltage: AC200V 50/60Hz)

Model	Power consumption (kVA)	Primary side NFB rating (A)	Maximum lead length by power cable size (m)			Minimum ground cable size (mm)
			2.0mm ²	3.5mm ²	5.5mm ²	
RT-30	1.0	10	97	170	268	2.0
RT-50	1.0	10	97	170	268	2.0
RT-100	1.7	15	58	102	160	2.0

▼Shaft Plan(S-single opening)

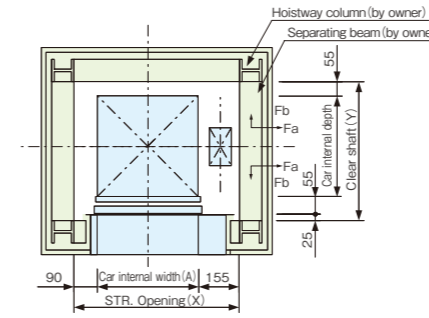

▼Shaft Plan(D-double opening)

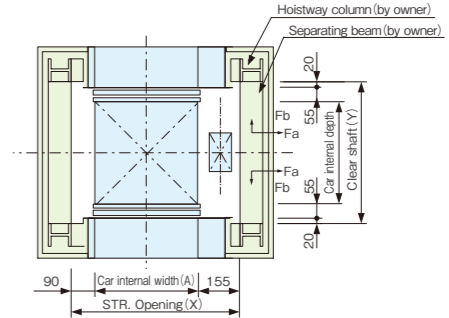

▼Entrance front view

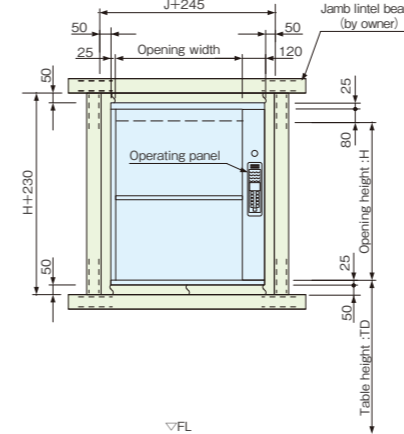

▼Shaft Plan (LD-front and side opening)

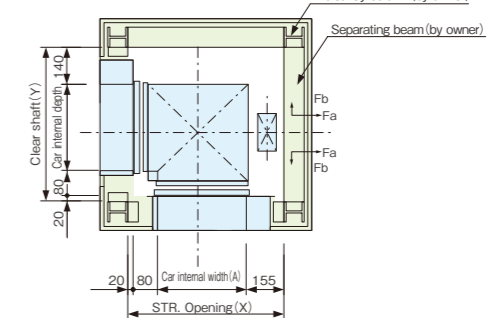

▼Machine room plan

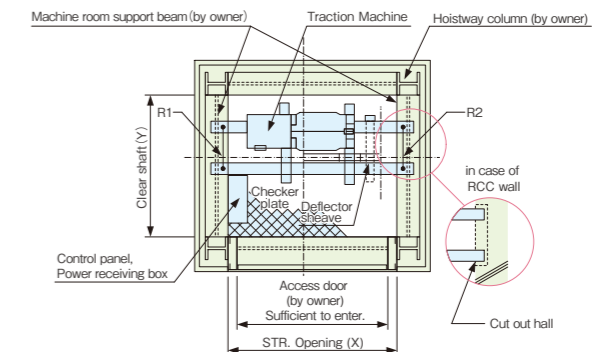

▼Horizontal Dimensions and Reaction Loads for pit

Rated capacity	Reaction Loads for pit [kN]		Horizontal loads [N]			
	P1	P2	Fa	Fb	Fc	Fd
30kg	8.6	7.1	203	181	-	-
50kg	11.6	9.0	261	232	-	-
100kg	18.4	13.3	458	478	-	-

RT Type(Table Type) Dimensions

Model	Rated Capacity (kg)	Motor (kW)	Rated Speed (m/min)	Entrance opening	Car internal (mm) (A × B × H)	Hoistway dimensions (mm)			Entrance (mm) (J × H)	Pit (mm) P	Table height (mm) TD	Reaction loads for machine room		No. of Car shelf boards
						X	Y	OH				R1 (kN)	R2 (kN)	
RT-30-S-45	30	0.4	45	Single	500×500×750	745	635	1425	500×750	700	700	1.3	2.5	1
				Front and rear		650								
				Front and side		755								
RT-50-S-45	50	0.4	45	Single	600×600×750	845	735	1425	600×750	700	700	1.7	3.0	1
				Front and rear		750								
				Front and side		855								
RT-100-S-45	100	0.75	45	Single	750×750×900	995	885	1650	750×900	650	650	2.8	4.6	2
				Front and rear		900								
				Front and side		1005								

●Please consult if the travel exceeds 15m.



RL

[Floor Type]

Loading Capacity:
200kg/300kg/500kg

The RL type is capable of transporting handcarts and service tables.

The RL type is available to three types corresponding to the load capacity : 200kg, 300kg, and 500kg. The maximum car size of 1000 (W)□1000(D)□1200 (H) (mm) offers a comfortable amount of transporting space.

*Major types of application / Schools, banks, laboratories, industrial premises



Standard Color variation

*Please note that the actual color may vary slightly from the above due to the printing process.

NEW



Natural White No.701



Right Gray No.602



Pink Blossom No.603

Specification

Standard Specification

Stainless Steel design specification (Optional feature)

Item	Material	Front surface finish	Material	Front surface finish
Jamb (W=300mm or less)	Steel Plate	Painted finish	Stainless Steel	Hairline finish
Hatch door (Bi-parting)				
Sill	Angle steel			
Cage (ceiling, wall)	Steel Plate	Painted finish	Stainless Steel	Hairline finish
Cage (floor)				
Cage (Bi-parting)				
Operating Panel	ABS resin	—	ABS resin or stainless face plate	

Recommended Option



Stainless steel finish

Rust-resistant stainless steel can be applied to decorative surfaces. This also contributes to a sanitary environment.

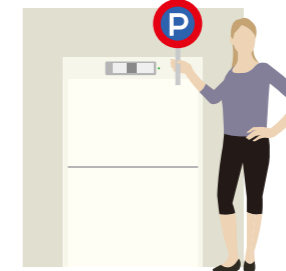

Operation pause switch

This function locks all doors when an operation pause status exists. It prevents mischievous operations, etc.



Cage Lamp (LED)

Cage lighting ensures that delivered items are clearly visible in dark environments.

RL [Floor Type Structure]

▼Structure(Steel frame structure)

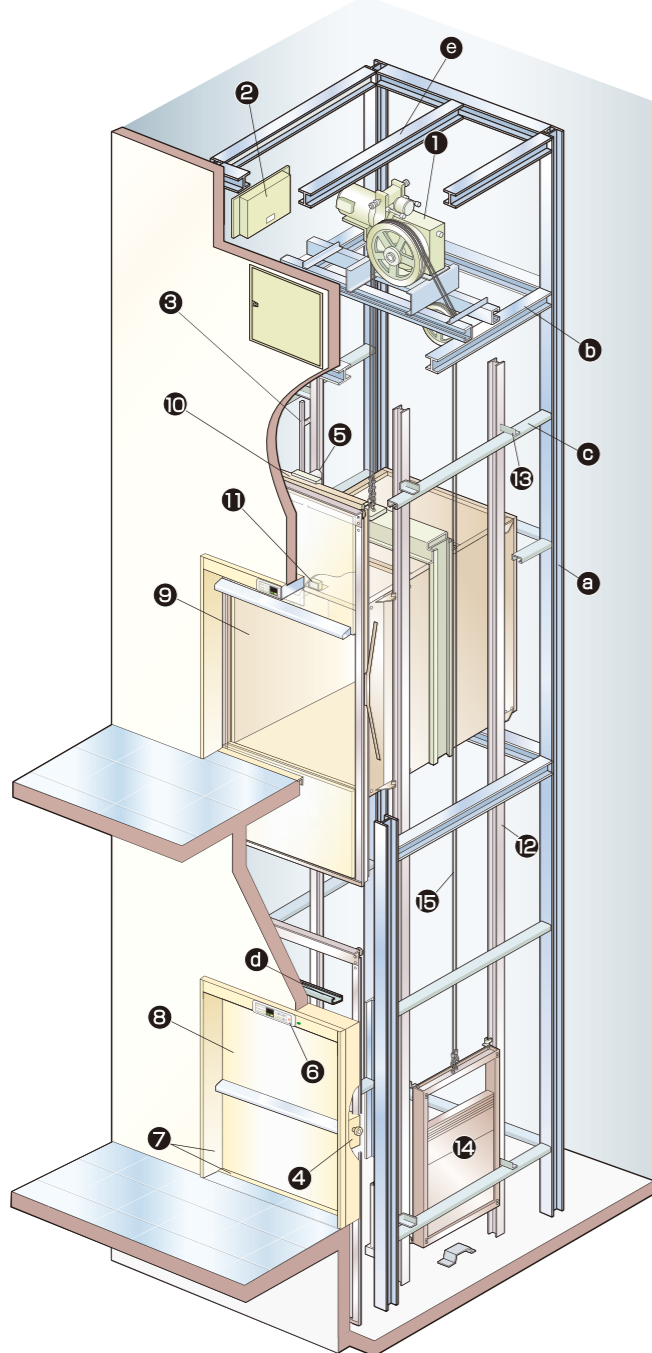

- 1 Traction Machine
- 2 Control panel, Power receiving box
- 3 Landing switch
- 4 Door locking device
- 5 Door motor
- 6 Operating panel
- 7 Jamb, Table
- 8 Hatch door (Bi-parting)
- 9 Car
- 10 Car door (Bi-parting)
- 11 Car gate switch
- 12 Guide rail
- 13 Rail bracket
- 14 CWT
- 15 Hoisting rope
- 16 Hoistway column (by owner) - H-100×100×6×8 or bigger
- 17 Machine room support beam (by owner) - H-100×100×6×8 or bigger
- 18 Separating beam (by owner) - C-100×50×20×3.2 or bigger L-50×50×6 or bigger
- 19 Jamb lintel beam (by owner) - C-100×50×20×3.2 or bigger L-50×50×6 or bigger
- 20 Lifting beam - H-100×100×6×8 or bigger

* a - d show a typical example. Details may differ depending on specifications.

Steel Construction ■ Dumbwaiter ■ Others

▼Shaft Elevation

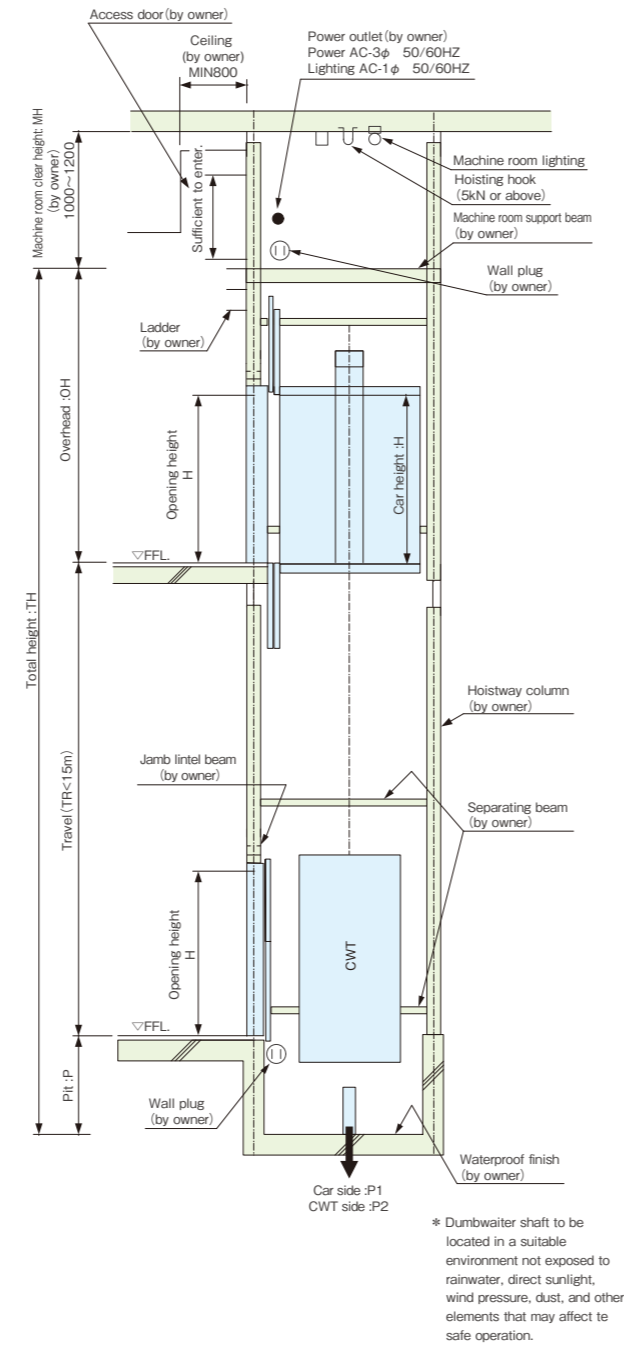

* Dumbwaiter shaft to be located in a suitable environment not exposed to rainwater, direct sunlight, wind pressure, dust, and other elements that may affect to safe operation.

Power Feeder Data(power supply voltage: AC200V 50/60HZ)

Model	Power consumption (kVA)	Primary side NFB rating (A)	Maximum lead length by power cable size (m)				Minimum ground cable size (mm)
			2.0mm ²	3.5mm ²	5.5mm ²	8.0mm ²	
RL-200	3.0	20	29	51	80	116	2.0
RL-300	4.1	20	21	37	58	85	2.0
RL-500	4.1	20	21	37	58	85	2.0

▼Shaft Plan(S-single opening)

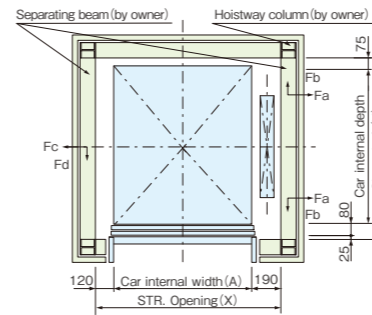

▼Shaft Plan(D-double opening)

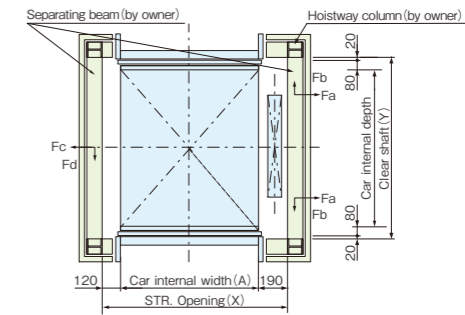

▼Entrance front view

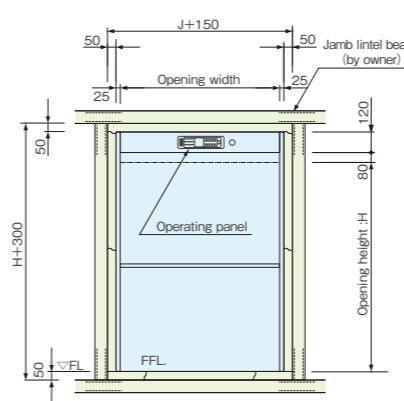

▼Shaft Plan(LD-front and side opening)

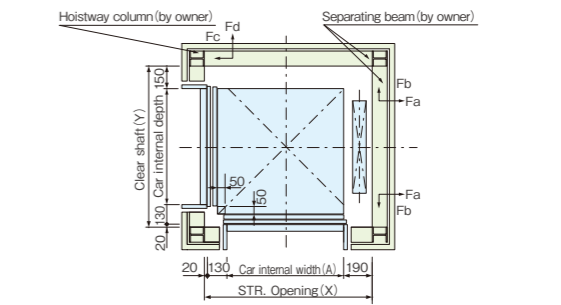

▼Machine room plan

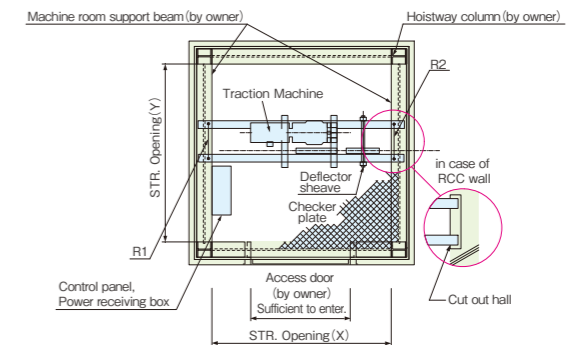

▼Horizontal Dimensions and Reaction Loads for pit

Rated capacity	Reaction Loads for pit [kN]		Horizontal loads [N]			
	P1	P2	Fa	Fb	Fc	Fd
200kg	34.7	24.4	906	1005	161	565
300kg	43.2	27.8	1007	1075	188	658
500kg	31.5	18.4	1316	1389	249	871

RL Type(Floor Type) Dimensions ■: Newly added cage sizes

Model	Rated Capacity (kg)	Motor (kW)	Rated Speed (m/min)	Entrance opening	Car internal (mm) (A × B × H)			Hoistway dimensions (mm)		Entrance (mm) (J × H)	Pit (mm) P	Reaction loads for machine room		Roping
					X	Y	OH	R1 (kN)	R2 (kN)					
RL-200-S-45	200	1.5	45	Single	850×1150×1200	1160	1330	2100	850×1200	700	6.0	8.6	1:1	
					900×900×1200	1210	1080							
					900×1100×1200	1210	1280							
					1000×1000×1200	1310	1180							
RL-200-D-45	200	1.5	45	Front and rear	850×1150×1200	1160	1350	2100	850×1200	700	7.2	10.3	1:1	
					900×900×1200	1210	1100							
					900×1100×1200	1210	1300							
					1000×1000×1200	1310	1200							
RL-200-LD-45	200	1.5	45	Front and side	900×900×1200	1240	1200	2100	900×1200	700	7.9	15.4	2:1	
					950×950×1200	1290	1250							
					900×900×1200	1240	1200							
					950×950×1200	1290	1250							
RL-300-S-45	300	2.2	45	Single	850×1150×1200	1160	1330	2100	850×1200	700	7.9	15.4	2:1	
					900×900×1200	1210	1080							
					900×1100×1200	1210	1280							
					1000×1000×1200	1310	1180							
RL-300-D-45	300	2.2	45	Front and rear	850×1150×1200	1160	1350	2100	850×1200	700	7.9	15.4	2:1	
					900×900×1200	1210	1100							
					900×1100×1200	1210	1300							
					1000×1000×1200	1310	1200							
RL-300-LD-45	300	2.2	45	Front and side	900×900×1200	1240	1200	2100	900×1200	700	7.9	15.4	2:1	
					950×950×1200	1290	1250							
					900×900×1200	1240	1200							
					950×950×1200	1290	1250							
RL-500-S-23	500	2.2	23	Single	850×1150×1200	1160	1330	2100	850×1200	700	7.9	15.4	2:1	
					900×900×1200	1210	1080							
					900×1100×1200	1210	1280							
					1000×1000×1200	1310	1180							
RL-500-D-23	500	2.2	23	Front and rear	850×1150×1200	1160	1350	2100	850×1200	700	7.9	15.4	2:1	
					900×900×1200	1210	1100							
					900×1100×1200	1210	1300							
					1000×1000×1200	1310	1200							
RL-500-LD-23	500	2.2	23	Front and side	900×900×1200	1240	1200	2100	900×1200	700	7.9	15.4	2:1	
					950×950×1200	1290	1250							

●Please consult if the travel exceeds 15m.



RU

[Unit Type]

Loading Capacity:
30kg/50kg/75kg/ **NEW** 100kg

The RU Type features an integrated design of the RT Type dumbwaiter and the hoistway.
The RU type dumbwaiter is installable in existing buildings as well.

The RU type is available to three types corresponding to the load capacity: 30Kg, 50Kg, and 75kg. This unit type dumbwaiter can be easily installed in existing offices, factories, warehouses in the short construction period.

•Major installation locations/restaurants, stores, houses



Standard Color

NEW



No. 701 : Natural White

*Please note that the actual color may vary slightly from the above due to the printing process.

Specification

Standard Specification

Item	Material	Front surface finish
External panel	Steel sheet	Painted (No.701)
Jamb		
Service door (bi-parting)		
Table	Stainless steel	Hairline finished
Cage (ceiling and walls)	Steel sheet	Painted(No.701)
Cage (shelf board)	Stainless steel	Hairline finish
Cage (floor)	Stainless steel	Hairline finish
Cage door (bi-parting)	Steel sheet	Painted(No.701)
Operating panel	ABS resin	—

Stainless Steel design specification (Optional Specification)

Material	Front surface finish
Stainless steel	Hairline finish
ABS resin or stainless steel face plate	

Recommended option (with additional cost)



Additional Shelf

One additional shelf is available, depending on the size of deliverables.

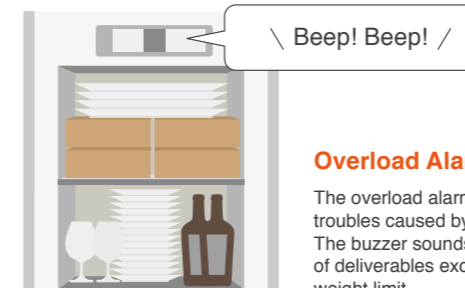

Overload Alarm Device

The overload alarm device prevents troubles caused by overload. The buzzer sounds when the weight of deliverables exceed the loading weight limit.



Cage Lamp (LED)

Cage lighting ensures that delivered items are clearly visible in dark environments.

[Overall View]



RU ▶ [Standard Unit type frame structure]

■ Dumbwaiter ■ Others

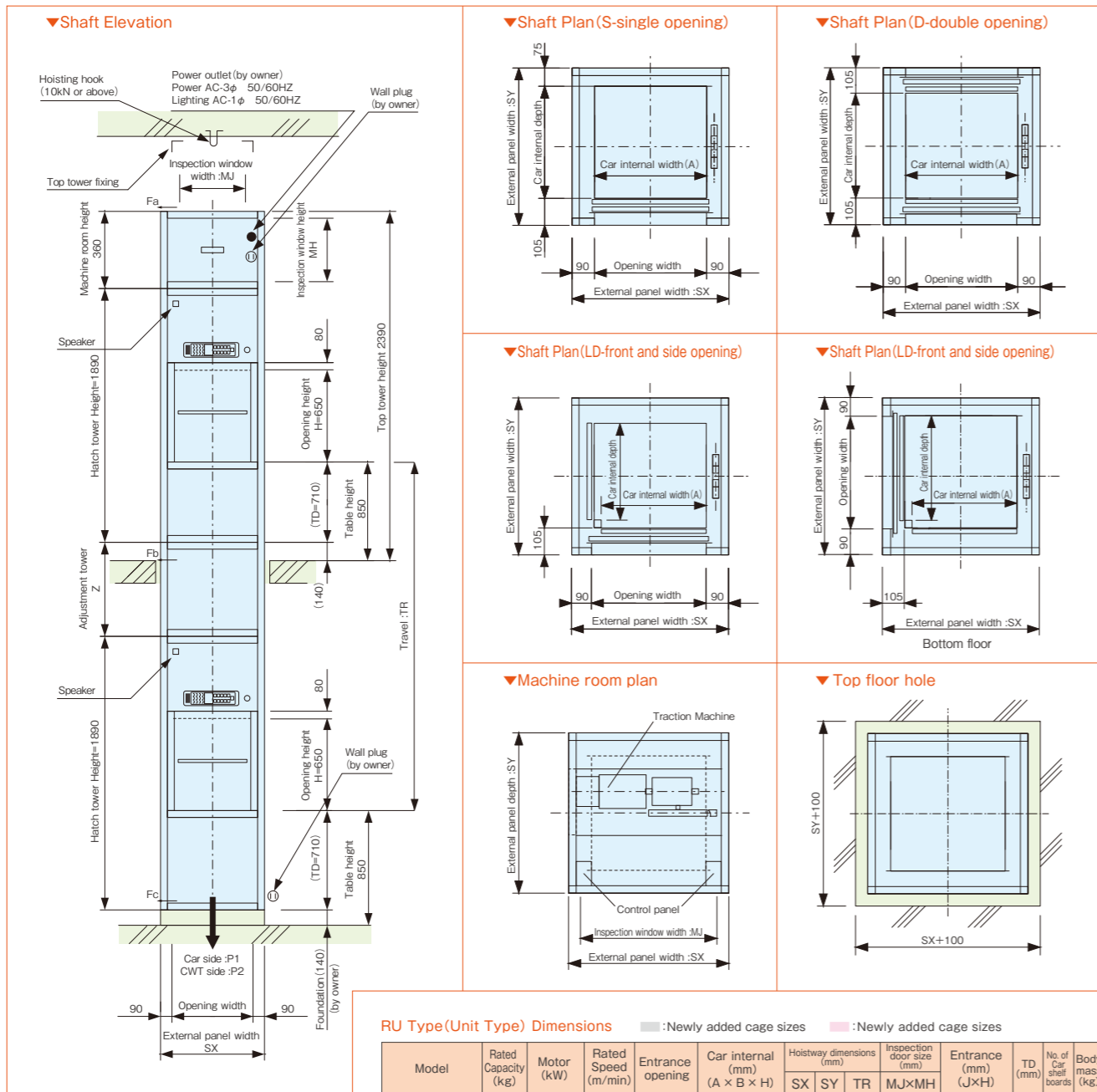

RU Type (Unit Type) Dimensions ■: Newly added cage sizes ■: Newly added cage sizes

Model	Rated Capacity (kg)	Motor (kW)	Rated Speed (m/min)	Entrance opening	Car internal (mm) (A × B × H)	Hoistway dimensions (mm)			Inspection door size (mm) MJ×MH	Entrance (mm) (J×H)	TD (mm)	No. of Car shaft boards	Body mass (kg)
						SX	SY	TR					
RU-30-S-45	30	0.4	45	Single	500×500×650	680	680	MAX 12m	550×296	500×650	710	1	530
RU-30-D-45				Front and rear	500×470×650								
RU-30-LD-45				Front and side	460×460×650								
RU-50-S-45	50	0.4	45	Single	500×500×650	780	780	MAX 12m	550×296	500×650	710	1	610
RU-50-D-45				Front and rear	500×470×650								
RU-50-LD-45				Front and side	460×460×650								
RU-75-S-45	75	0.4	45	Single	600×600×650	880	880	MAX 12m	650×296	600×650	710	1	720
RU-75-D-45				Front and rear	600×570×650								
RU-75-LD-45				Front and side	560×560×650								
RU-100-S-45	100	0.75	45	Single	700×700×650	880	880	MAX 12m	750×296	700×650	710	1	770
RU-100-D-45				Front and rear	700×670×650								
RU-100-LD-45				Front and side	660×660×650								

Power Feeder Data (power supply voltage: AC200V 50/60Hz)

Model	Power consumption (kVA)	Primary side NFB rating (A)	Maximum lead length by power cable size (m)			Minimum ground cable size (mm)
			2.0 mm	3.5 mm	5.5 mm	
RU-30	1.0	10	97	170	268	2.0
RU-50	1.0	10	97	170	268	2.0
RU-75	1.0	10	97	170	268	2.0
RU-100	1.7	15	58	102	160	2.0

RU ▶ [Unit Type Structure with Wall by Owner] ※In case of fireproof building

■ Dumbwaiter ■ Others

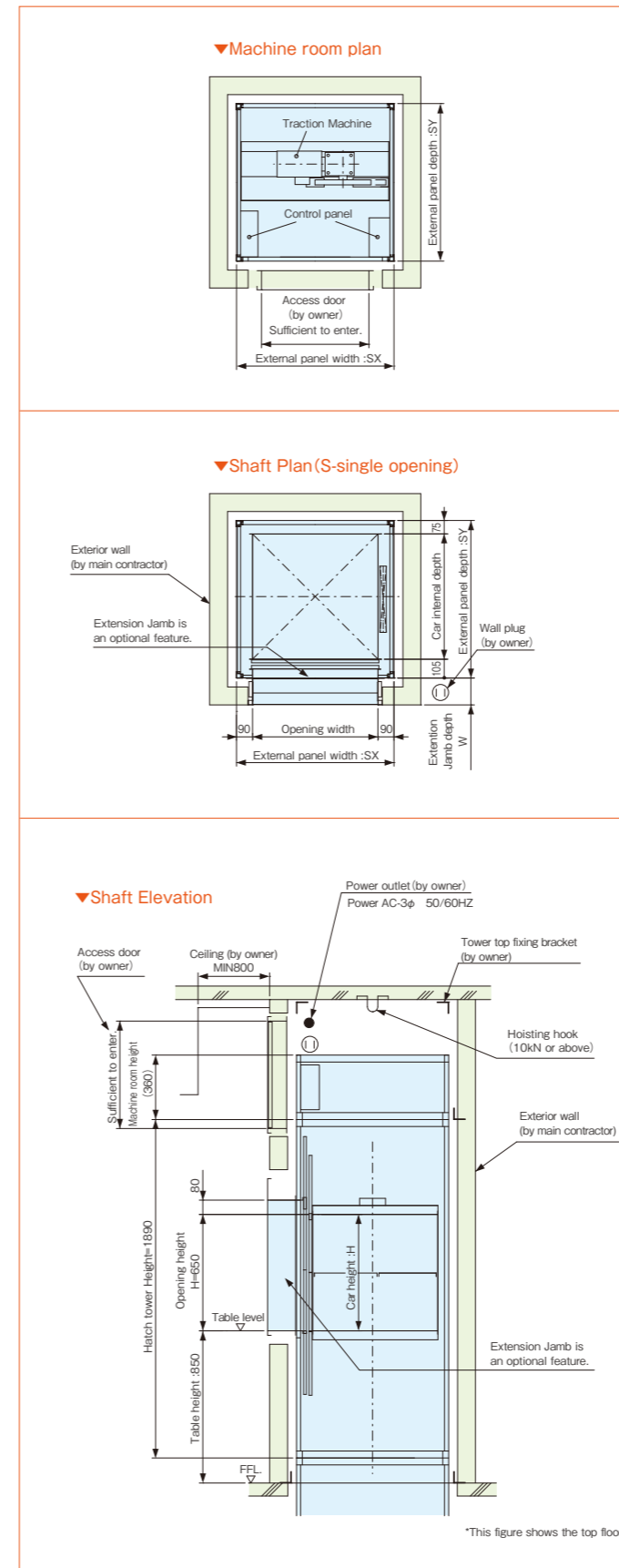

▼ Horizontal Dimensions and Reaction Loads for pit

Rated capacity	Reaction Loads for pit [kN]			Horizontal loads [N]		
	P1	P2	Fa	Fb	Fc	
30kg	7.7	6.2	595	838	331	
50kg	10.3	7.7	673	970	386	
75kg	13.3	9.5	821	1114	447	
100kg	16.3	11.2	871	1213	496	

*Horizontal loads are the same for every side.

Ryoden Dumbwaiter G Series Specificcation Table



Standard specification

Item	RT Table Type			RL Floor Type			RU Unit Type			
	30	50	100	200	300	500	30	50	75	NEW 100
Elevator use	Dumbwaiter									
Drive format	Traction type									
Capacity	30kg	50kg	100kg	200kg	300kg	500kg	30kg	50kg	75kg	100kg
Number of stops	Up to 8 stops			Up to 8 stops			Up to 3 stops			
Number of openings	Up to 8 openings			Up to 8 openings			Up to 3 openings			
Travel	TR<30m(※1)			TR<30m(※1)			TR<12m			
Rated speed	45m/min			45m/min		23m/min	45m/min			
Control	Invertor control									
Hatch door side	S-Single opening / D-Double opening (front and rear) /LD- Double opening (front and side)									
Hatch door	Bi-parting (manually operated)									
Car door	Bi-parting (motor drive)									
Operation	Hands-free interphone									
Energy saving	Automatic energy saving mode									
Signal device	Chime, cage position display, error code display, caution buzzer									
Safety device	Door lock, hatch door gate switch, emergency stop button, limit switch, A.S.T system									
Power supply	3-phase 200VAC, 50/60Hz									

Optional feature

●:Standard specification ○:Optional feature

Category	Item	RT Table Type	RL Floor Type	RU Unit Type
Design	Jamb	○	○	○
	Sill	—	○	—
	Table	●	—	●
	Hatch door	○	○	○
	Cage door	○	○	○
	Cage ceiling, wall	○	○	○
	Shelf	●	—	●
	Cage floor	●	○	●
	Exterior tower	—	—	○
	Stainless cover for operating panels	○	○	○
	Swing cover for operating panel (Steel plate / stainless steel)	○	○	○
	Special color	○	○	○
	Wide jamb (300mm≦ W < 500mm)	○	○	○
	Wide sill (65mm≦ W < 500mm)	—	○	—
Wide table (65mm≦ W < 500mm)	○	—	○	
Additional shelf (up to 1PC.)	○	—	○	
Antibacterial sheet	○	○	○	
Service functions	Operation pause switch (parking function)	○	○	○
	Motor drive hatch door	○	○	—
	Foot switch	○	○	○
	Overload alarm device	●	●	○
	Return-to-reference-floor function	○	○	○
	Higher harmonic resistance (reactor)	○	○	○
	Higher harmonic resistance (noise filter)	○	○	○
	Single phase	○	○	○
	Custom operation mode	○	○	○
	Service door lock	○	○	○
Hoistway	Handset interphone (Operating panel will be SUS finish)	○	○	○
	Big volume speaker	○	○	○
	Floor height more than 5m	○	○	—
Unit type	Same floor double opening	○	○	○LD is not available for RU
	Car, CWT safety	○	○	—
	Special floor height	—	—	○
	Machine room top extension tower	—	—	○
	Unit type foundation (Steel plate: H=140)	—	—	○
	Unit type hatch door extension jamb (Steel plate: W<300mm)	—	—	○
Unit type hatch door extension jamb(Stainless steel: W<300mm)	—	—	○	
Front panel only (shaft walls are constructed by owner)	—	—	○	

*1: For travel more than 15m and less than 30m, the traction machine, power supply will be ranked up.

The operating panel is shown in the horizontally oriented type for shutdown (4).

Operation Description

Operation of each section on the operating panel

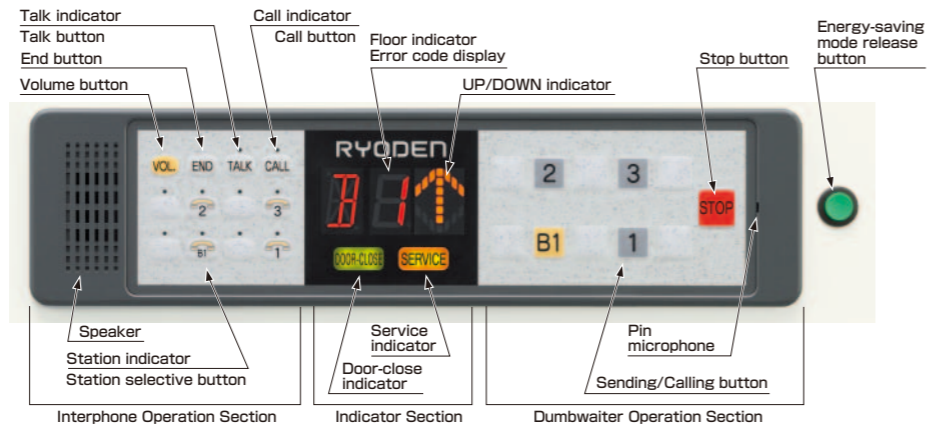

Automatic energy-saving mode

The operation panel's indicator lamps are switched OFF and the energy-saving mode (control power OFF) is automatically established if the dumbwaiter is not operated within 10 minutes after the Service indicator lamp switches OFF.

To resume dumbwaiter operation from this status, simply press the Energy-saving mode release button.

* The energy-saving mode is disabled when an error is active (when an error No. is displayed)

* The energy-saving mode is automatically established when the dumbwaiter is not in use, even if the interphone is in use or a standby status exists.

Operation of Each Section on the Operating Panel

① Dumbwaiter operation section

Item	Function
Sending/Calling button (your floor is indicated in yellow.)	<ul style="list-style-type: none"> ● Calls or sends the car. ● The target floor name in the indicator section flickers when registered.
Stop button	<ul style="list-style-type: none"> ● Stops the car when the car senses an error during operation. ● The "E0" lamp in the error code display turns on while the button is pressed.

② Indicator Section

Item	Function
Travel indicator (orange)	<ul style="list-style-type: none"> ↑ : Indicates the car is upward. ↓ : Indicates the car is downward.
Floor indicator (red)	<ul style="list-style-type: none"> ON : Indicates the name of the floor where the car is stopped. Flicker : Indicates the target floor name while the car is traveling.
Error code display (red)	E0 to E9 and EA, Eb : Indicates an error occurred.
Door-close indicator (green)	● Indicates that the service door and car door are fully closed.
Service indicator (yellow)	● Indicates that the service door is open, or that the car is in operation.

③ Interphone operation section

Item	Function
Station selective button (indicator: red)	<ul style="list-style-type: none"> ● Talk with the target floor. ● The indicator turns on when the station is selected.
Call button (indicator: red)	<ul style="list-style-type: none"> ● Sounds in tremolo on the selected floor. (This button also allows you to call the selected floor by voice.) ● The indicator turns on while the call button is pressed.
Talk button (indicator: red)	<ul style="list-style-type: none"> ● Switches the talk mode from hands-free to press-talk. ● The indicator turns on in press-talk mode. (The indicator turns off in hands-free talk mode.) ● The indicator turns on when the interphone is in use in an area other than your station.
End button	● Ends talking.
Volume button	● Adjust the volume of the call, talk, and auto announcement sound to one of three levels, in the order of low R medium R high.
Speaker	● Sounds call, talk, and auto announcement.
Pin Microphone	● Picks up voices. (The microphone is highly sensitive and does not require proximity during talking.)

WORKS NOT INCLUDED IN INSTALLATION CONTRACT

1. THE CONSTRUCTION WORKS OF HOISTWAY AND MACHINE ROOM.
2. HOLES OF MACHINE ROOM FLOOR AND OPENINGS OF EACH FLOOR.
3. MACHINE ROOM ENTRANCE.
4. OPENING FOR CARRYING CONTROL PANEL AND MACHINE, AND THEIR POURING.
5. PIT WATERPROOF WORKS.
6. WIRINGS FOR POWER SUPPLY INCLUDING EARTHING TO POWER RECEIVING BOX IN MACHINE ROOM.
7. WIRING FOR SIGNAL POWER SUPPLY TO POWER RECEIVING BOX IN MACHINE ROOM.
8. ILLUMINATION EQUIPMENT WORKS IN MACHINE ROOM AND ELECTRIC OUTLET FOR INSPECTION.
9. IF A GROUND FAULT INTERRUPTER IS USED AS THE CIRCUIT BREAKER, SET THE CURRENT SENSITIVITY TO 100 mA OR GREATER.

How to Use the Dumbwaiter Operation Section

- 1 Call the car. Press the button of your floor (yellow).
- 2 The car arrives.
- 3 Load the deliverables. Open the service door manually and load the deliverables.
- 4 Send the car. Manually close the service door, and press the sending/calling button of the destination floor.
- 5 The car arrives.
- 6 Receive the deliverables. Manually open the service door, and carefully remove the deliverables. After use, manually close the service door.

Remarks
<ul style="list-style-type: none"> ● The service indicator turns on when a car call registration command is received. ● Whether or not the car is on your floor is verifiable by viewing the floor indicator (flickering) and sending/calling indicator (on).
<ul style="list-style-type: none"> ● Car arrival is indicated by the sending/calling indicator turning off and the bells chime. In addition, the car door automatically opens and the service indicator turns off. ● The service indicator turns on once again when the service door is opened.
<ul style="list-style-type: none"> ● The service indicator turns on when a car send registration command is received. ● The car door automatically closes. ● The door-close indicator turns on when the service door and car door are fully closed. ● The start of car travel can be checked by viewing the floor indicator (flickering) of the target floor and the sending/calling indicator (on).
<ul style="list-style-type: none"> ● Car arrival is indicated by chime. In addition, the car door automatically opens and the service indicator turns off. ● The service indicator turns on once again when the service door is opened. ● The car door also automatically closes and the door-close indicator turns on when the service door is closed. ● When the service indicator turns off, the car waits for the next call/send command.

How to Use the Interphone Operation Section

When calling and talking to another party.

- 1 Call the other party. Press the station selective button of the name of the floor of the party with whom you want to talk, and press the call button.
- 2 Wait for a response from the party.
- 3 Talk with the party. [Hands-free talk mode] Talk as is without pressing any buttons. [Press-talk talk mode] Talk while pressing the talk button.
- 4 End talking. Press the end button.

Remarks
<ul style="list-style-type: none"> ● It is not possible to talk with multiple parties at once. ● The station indicator turns on when the station is selected. ● A tremolo sound is produced on the selected floor when the call button is pressed. Call by voice is also possible.
<ul style="list-style-type: none"> ● Once the other party responds, you can talk with each other in hands-free mode. ● The mode switches to press-talk mode and the talk indicator turns on as soon as the talk button is pressed. <p>※ When changing the selected station floor, press the station button of the target station. (Sequential send function)</p>
<ul style="list-style-type: none"> ● Operate the end button on the call side. The call/talk indicator on the floor of the other party turns off.

When called from another party

- 1 A call arrives from another party. A call arrives, indicated by a tremolo or voice sound.
- 2 Respond to the party. Respond by voice in hands-free mode.

Remarks
<ul style="list-style-type: none"> ● The call indicator and talk indicator turn on.
<ul style="list-style-type: none"> ● After responding, you can talk with the other party in hands-free mode. (Mutual, hands-free talk mode)

How to Adjust the Volume

- [Adjusting the volume of the call sound] Press the volume button while pressing the call button.
- [Adjusting the volume of the talk sound] Press the volume button while pressing the talk button.
- [Adjusting the volume of the alarm and chime] Press the volume button while pressing the end button.

Remarks
<ul style="list-style-type: none"> ● A confirmation ring sounds in the order of low R medium R high.
<ul style="list-style-type: none"> ● A confirmation chime sounds in the order of low R medium R high.

NOTES

1. VOLTAGE FLUCTUATION SHALL BE WITHIN +5% ~ -10%
2. THE FOLLOWING CONDITIONS ARE REQUIRED FOR MAINTAINING THE PREDETERMINED PERFORMANCE.
 - (1) ENSURE THAT A 0°C TO 40°C TEMPERATURE IS MAINTAINED IN THE MACHINE ROOM AND THE UP/DOWN PASSAGEWAY, WITH THE AVERAGE MONTHLY HUMIDITY NOT EXCEEDING 90%, AND THE AVERAGE DAILY HUMIDITY NOT EXCEEDING 95%.
 - (2) MOISTURE SHOULD BE BELOW 90% ON A MONTHLY AVERAGE AND BELOW 95% ON A DAILY AVERAGE.
 - (3) MACHINE ROOM AND THE HOISTWAY SHOULD BE FREE OF DUST OR HARMFUL GAS.
3. THE TUBE APPARATUS FOR ELECTRICITY OR WATER SUPPLY SHALL NOT BE BURIED INTO HOISTWAY WALL.



RYODEN ELEVATOR CONSTRUCTION LTD

NAGOYA WORKS:1-25 NISHIMATABEICHO.
MINAMI-KU. NAGOYA. AICHI 457-0835 JAPAN
TEL.: +81-52-618-3261

